

02 | CLASSIC

Espresso Italiano







S03

Batteria lavabo 3 fori con canna girevole
Ø 26 mm, scarico 1" 1/4 lusso
3 holes basin group, swivelling spout
Ø 26 mm, 1" 1/4 pop-up waste
 Batterie de lavabo 3 trous avec goulot rond orientable **Ø 26 mm**, vidage 1"1/4 de luxe

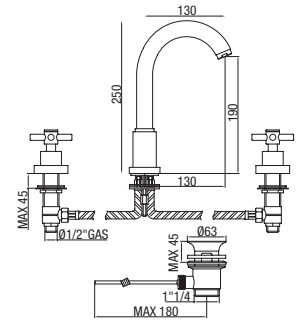

S08

Monoforo lavabo, scarico 1" 1/4 lusso
Single hole basin group, 1" 1/4 pop-up waste
 Batterie de lavabo monotrou, vidage 1" 1/4 de luxe

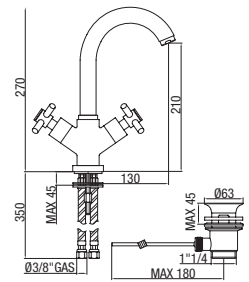

S15-165

Lavabo incasso **bocca Ø 20 mm**,
interasse 165 mm
Built-in basin group, 165 mm wheelbase,
Ø 20 mm spout
 Batterie de lavabo à encastrer,
goulot Ø 20 mm, écartement 165 mm

S15-230

Bocca interasse: 230 mm
Spout wheelbase: 230 mm
Goulot écartement: 230 mm

425

Universal 1" 1/4



426

Universal 1" 1/4



329

Prolunga
 Extension
 Extension

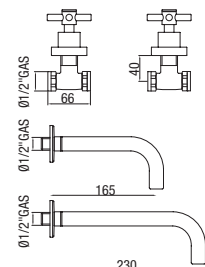

VC
(art.291DX)



S05

Batteria bidet 3 fori con canna girevole
 $\varnothing 26$ mm, scarico 1" 1/4 lusso
*3 holes bidet group, $\varnothing 26$ mm swivelling spout,
 1" 1/4 pop-up waste*
 Batterie de bidet 3 trous avec goulot rond orientable
 $\varnothing 26$ mm, vidage 1"1/4 de luxe

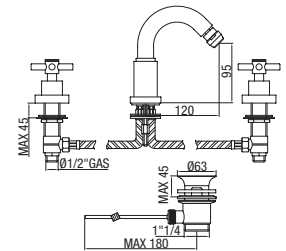

CR

VC
(art.291DX)



S10

Monoforo bidet, scarico 1" 1/4 lusso
Single hole bidet group, 1" 1/4 pop-up waste
 Batterie de bidet monotrou, vidage 1" 1/4
 de luxe

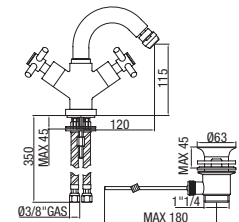

CR

VC
(art.291DX)



S12

Gruppo esterno doccia, attacco 1/2",
 non corredato di componenti
*External shower group without shower kit,
 1/2" fitting*
 Batterie de douche externe, raccord 1/2",
 sans flexible et sans douchette

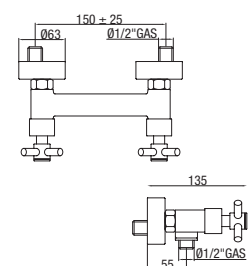

CR



S14

Rubinetto incasso singolo 1/2"
con sede riportata
Built-in single valve 1/2" fitting
Robinet de fermeture à encastrer,
raccord 1/2"



329

Prolunga
Extension
Extension

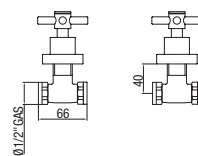

DUETTO





DUETTO

VC
(art.291DX)



801

Gruppo esterno vasca con doccia
External bath group with shower
Batterie de bain externe avec douchette

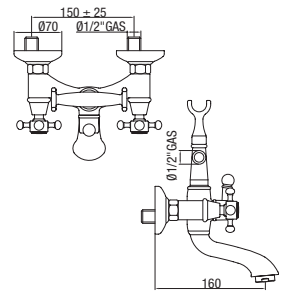

VC
(art.291DX)



802

Gruppo esterno vasca con doccia e duplex
External bath group with double system shower and duplex
Batterie de bain externe avec douchette et support

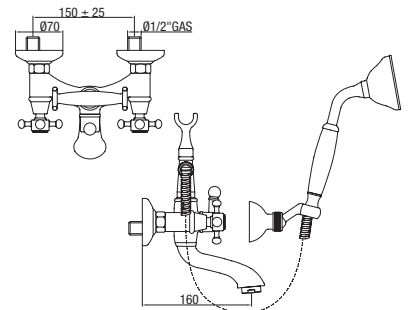

VC
(art.291DX)



821

Gruppo vasca con colonna telescopica
- supporto doccia scorrevole
- soffione in ottone anticalcare Ø 200 mm
- doccia in ottone
- flessibile 1500 mm doppia aggraffatura
Bath set mixer with swivelling column
- sliding support shower
- Ø 200 mm no-liming brass shower head
- brass shower
- double clamping 1500 mm flexible hose
Set de mitigeur de bain avec colonne telescopique
- support de douche glissant
- pomme de douche en laiton anticalcaire Ø 200 mm
- douchette en laiton
- flexible 1500 mm double agrafage

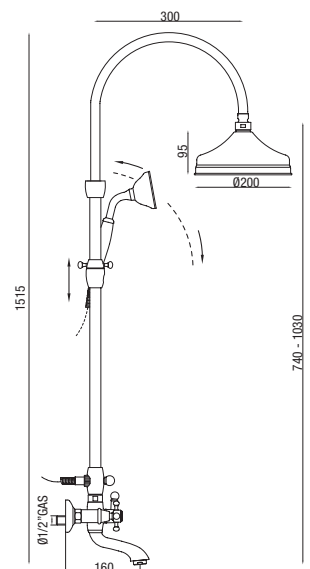

DUETTO

VC
(art.291DX)



820

Batteria lavabo 3 fori con canna anticata girevole
scarico 1" 1/4 lusso
*3 holes basin group with antique swivelling spout,
1" 1/4 pop-up waste*
Batterie de lavabo 3 trous, goulot orientable
style ancien, vidage 1"1/4 de luxe

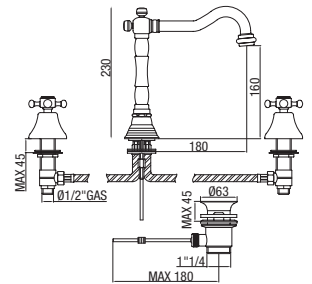

VC
(art.291DX)



803

Batteria lavabo 3 fori, scarico 1" 1/4
3 holes basin group, 1" 1/4 pop-up waste
Batterie de lavabo 3 trous, vidage 1"1/4

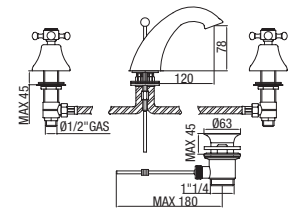

VC
(art.291DX)

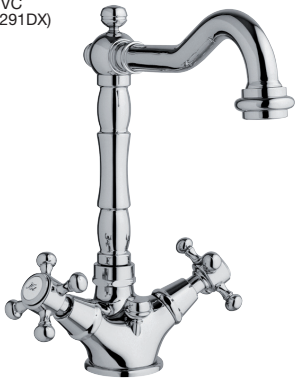

830

Gruppo monoforo lavabo con canna anticata
girevole scarico 1" 1/4
*Single hole basin group with antique swivelling
spout, 1" 1/4 pop-up waste*
Batterie de lavabo monotrou, goulot orientable
style ancien, vidage 1"1/4

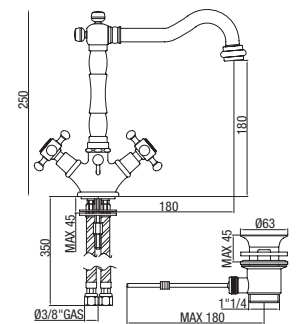

VC
(art.291DX)



808

Gruppo monoforo lavabo, scarico 1" 1/4
Single hole basin group, 1" 1/4 pop-up waste
Batterie de lavabo monotrou, vidage 1"1/4

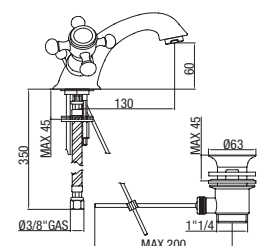



809

Gruppo monoforo lavabo alto, scarico 1" 1/4
High single hole basin group, 1" 1/4 pop-up waste
 Batterie de lavabo monotrou haute, vidage 1"1/4

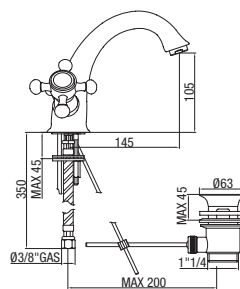

804

Lavabo incasso canna anticata
Built-in basin group with antique spout
 Batterie de lavabo à encastrer avec goulot style ancien

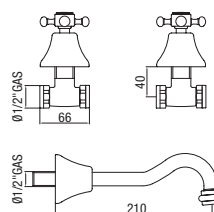

309
1" 1/4



329
Prolunga
Extension
Extension



825

Batteria bidet 3 fori con canna anticata girevole,
 scarico 1" 1/4 lusso
*3 holes bidet group with antique swivelling spout,
 1" 1/4 pop-up waste*
 Batterie de bidet 3 trous, goulot orientable
 style ancien, vidage 1"1/4 de luxe

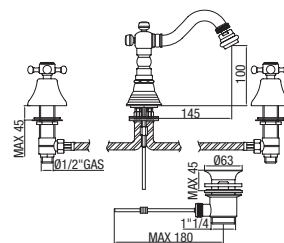

805

Gruppo bidet 3 fori, scarico 1" 1/4
3 holes bidet group, 1" 1/4 pop-up waste
 Batterie de bidet 3 trous, vidage 1"1/4

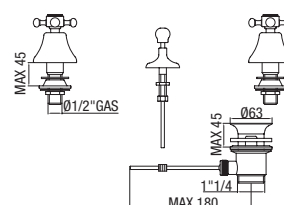

DUETTO

VC
(art.291DX)



835

Gruppo monoforo bidet con canna anticata girevole scarico 1" 1/4

Single hole bidet group with antique swivelling spout, 1" 1/4 pop-up waste

Batterie de bidet monotrou, goulot orientable style ancien, vidage 1"1/4

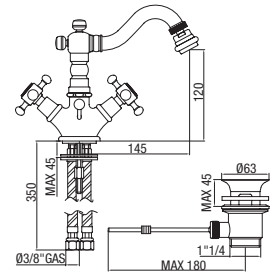

VC
(art.291DX)



810

Gruppo monoforo bidet, scarico 1" 1/4

Single hole bidet group, 1" 1/4 pop-up waste

Batterie de bidet monotrou, vidage 1"1/4

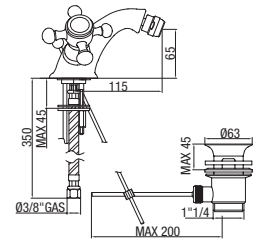

VC
(art.291DX)



829

Monoforo lavello con canna erogazione orientabile, h 210 mm

Single hole sink group, h 210 mm, swivelling spout

Batterie d'évier monotrou, goulot orientable, h 210 mm

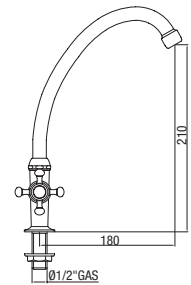

VC
(art.291DX)

806

Rubinetto incasso singolo 1/2" con sede riportata

Built-in single valve 1/2" fitting

Robinet de fermeture à encaster, raccord 1/2"

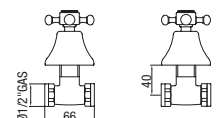

329

Prolunga
Extension
Extension



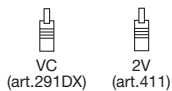

823-2V

Rubinetto incasso con deviatore 2 vie
Three-holes built-in group with 2 ways diverter
 Batterie trois trous à encastrer avec inverseur 2 voies

329

Prolunga
Extension
 Extension



329D

Prolunga
Extension
 Extension

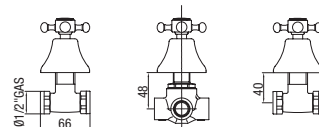

DUETTO



807

Gruppo esterno doccia, attacco 1/2",
 non corredato di componenti
*External shower group without shower kit,
 1/2" fitting*
 Batterie de douche externe, raccord 1/2",
 sans flexible et sans douchette

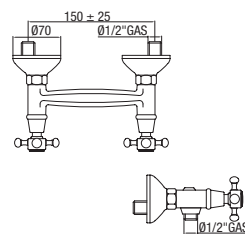

816

Gruppo esterno doccia, attacco 3/4" superiore,
 non corredato di componenti
*External shower group without shower kit,
 3/4" fitting*
 Batterie de douche externe, raccord 3/4",
 sans flexible et sans douchette

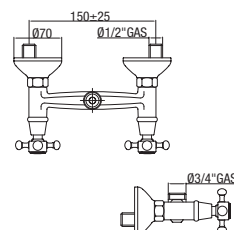

ARMONIA





ARMONIA

VC
(art.291SX)
(art.291DX)



600

Gruppo esterno vasca con doccia
External bath group with shower
Batterie de bain externe avec douchette

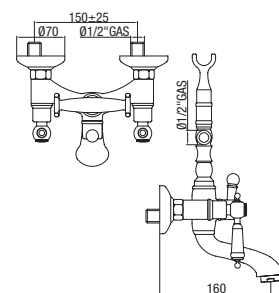

VC
(art.291SX)
(art.291DX)



605

Gruppo esterno vasca con doccia e duplex
External bath group with shower and duplex
Batterie de bain externe avec douchette
et support

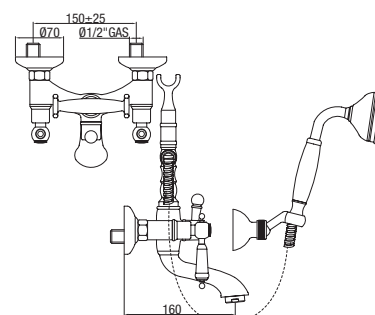

VC
(art.291SX)
(art.291DX)



622

Miscelatore vasca su colonna a pavimento
con doccia in ottone e flessibile 1500 mm
*Freestanding external bath mixer with brass shower
and 1500 mm flexible hose*
Mitigeur de bain externe sur colonne avec
douchette en laiton et flexible 1500 mm

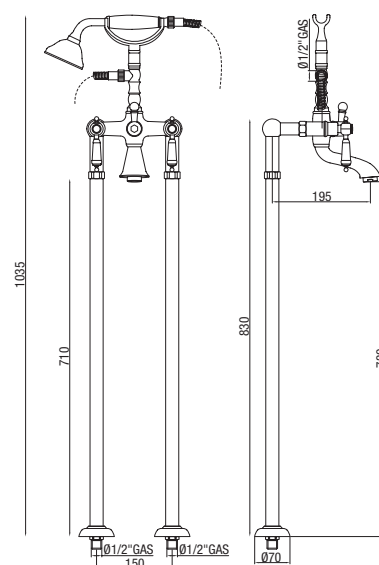

VC
 (art.291SX)
 (art.291DX)



620

Batteria lavabo 3 fori con canna anticata girevole scarico 1" 1/4

3 holes basin group with antique swivelling spout, 1" 1/4 pop-up waste

Batterie de lavabo 3 trous, goulot orientable style ancien, vidage 1"1/4

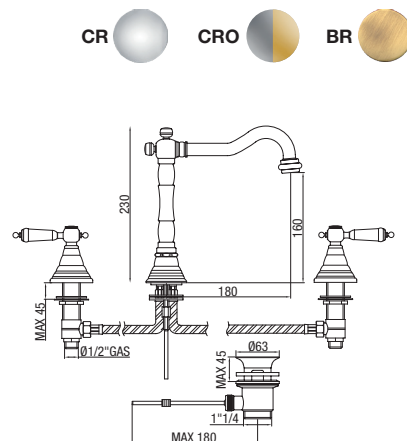

CR CRO BR

VC
 (art.291SX)
 (art.291DX)



630

Monoforo lavabo con canna anticata girevole scarico 1" 1/4

Single hole basin group with antique swivelling spout, 1" 1/4 pop-up waste

Batterie de lavabo monotrou, goulot orientable style ancien, vidage 1"1/4

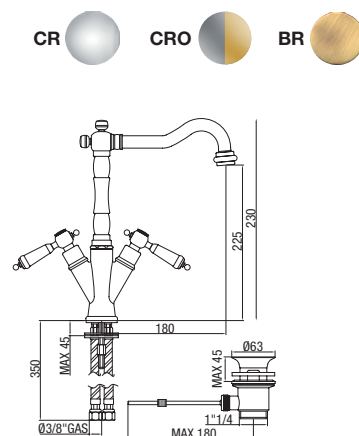

CR CRO BR

VC
 (art.291SX)
 (art.291DX)



604

Lavabo incasso canna anticata

Built-in basin group with antique spout

Batterie de lavabo à encastrer avec goulot style ancien

309
 1" 1/4



329
 Prolunga
 Extension
 Extension



CR CRO BR

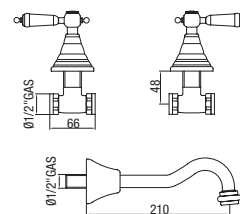

VC
 (art.291SX)
 (art.291DX)



615

Batteria bidet 3 fori con canna anticata girevole, scarico 1" 1/4

3 holes bidet group with antique swivelling spout, 1" 1/4 pop-up waste

Batterie de bidet 3 trous, goulot orientable style ancien, vidage 1"1/4

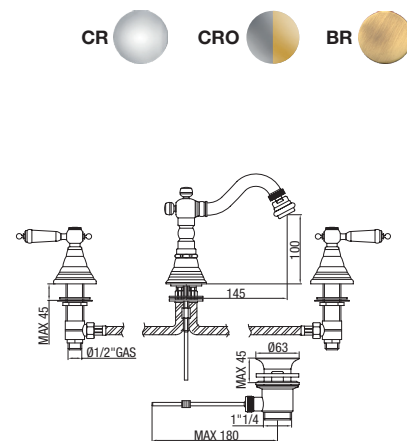

CR CRO BR

VC
(art.291SX)
(art.291DX)



625

Gruppo bidet 3 fori, scarico 1" 1/4
3 holes bidet group, 1" 1/4 pop-up waste
Batterie de bidet 3 trous, vidage 1"1/4

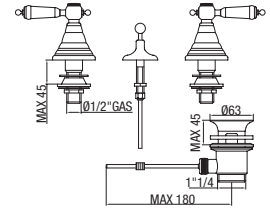

VC
(art.291SX)
(art.291DX)



635

Monoforo bidet con canna anticata girevole
scarico 1" 1/4
*Single hole bidet group with antique swivelling
spout, 1" 1/4 pop-up waste*
Batterie de bidet monotrou, goulot orientable
style ancien, vidage 1"1/4

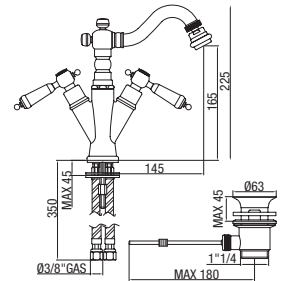

VC
(art.291SX)
(art.291DX)



606

Rubinetto incasso singolo 1/2"
con sede riportata
Built-in single valve 1/2" fitting
Robinet de fermeture à encastrer,
raccord 1/2"



329

Prolunga
Extension
Extension

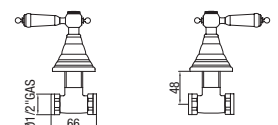

CR Cromo - Chrome - Chromé
CRO Cromo/Oro - Chrome/Gold - Chromé/OR
BR Bronzo spazzolato - Brushed old brass - Bronze brossé

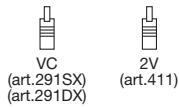

608-2V

Rubinetto incasso con deviatore 2 vie
Three-holes built-in group with 2 ways diverter
 Batterie trois trous à encastrer avec inverseur 2 voies

329

Prolunga
Extension
 Extension



329D

Prolunga
Extension
 Extension

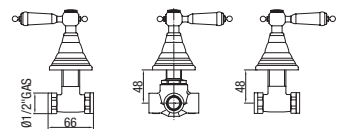

ARMONIA



607

Gruppo esterno doccia, attacco 1/2",
 non corredato di componenti
External shower group without shower kit, 1/2" fitting
 Batterie de douche externe, raccord 1/2",
 sans flexible et sans douchette

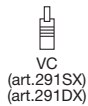
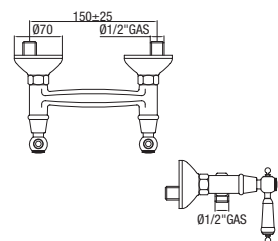

616

Gruppo esterno doccia, attacco superiore 3/4",
 non corredato di componenti
External shower group without shower kit, 3/4" fitting
 Batterie de douche externe, raccord 3/4",
 sans flexible et sans douchette

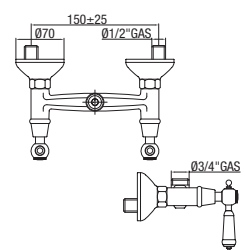

ARMONIA SW



VC
 (art.291SX)
 (art.291DX)



600SW

Gruppo esterno vasca con doccia
External bath group with shower
 Batterie de bain externe avec douchette

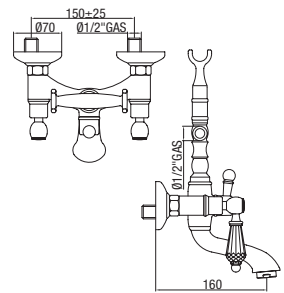

CR BR

VC
 (art.291SX)
 (art.291DX)



605SW

Gruppo esterno vasca con doccia e duplex snodato
External bath group with shower and duplex
 Batterie de bain externe avec douchette et support

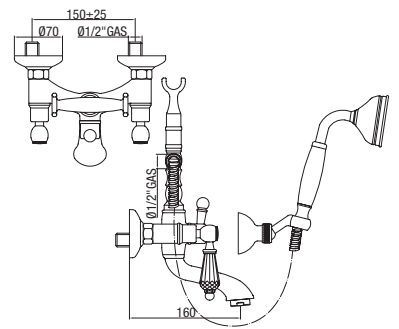

CR BR

VC
 (art.291SX)
 (art.291DX)



620SW

Batteria lavabo 3 fori con canna anticata girevole
 scarico 1" 1/4
*3 holes wash-basin group with antique swivelling
 spout, 1" 1/4 pop-up waste*
 Batterie de lavabo 3 trous, goulot orientable style
 ancien, vidage 1"1/4

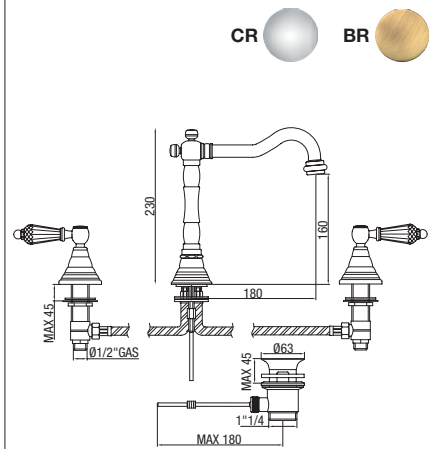

CR BR

VC
 (art.291SX)
 (art.291DX)



630SW

Monoforo lavabo con canna anticata girevole
 scarico 1" 1/4
*Single hole basin group with antique swivelling
 spout, 1" 1/4 pop-up waste*
 Batterie de lavabo monotrou, goulot orientable style
 ancien, vidage 1"1/4

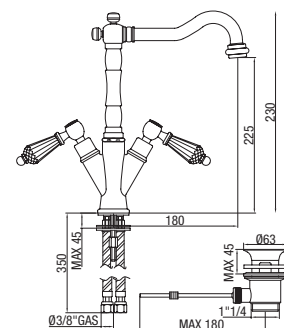

CR BR

ARMONIA SW

ARMONIA SW

VC
(art.291SX)
(art.291DX)



604SW

Lavabo incasso **bocca anticata Ø 22 mm,**
Built-in basin group, Ø 22 mm antique spout
Batterie de lavabo à encastrer,
goulot Ø 22 mm style ancien

309
1" 1/4



329
Prolunga
Extension
Extension



CR  BR 

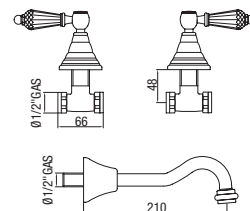

VC
(art.291SX)
(art.291DX)



615SW

Batteria bidet 3 fori con canna anticata girevole,
scarico 1" 1/4
3 holes bidet group with antique swivelling spout, 1" 1/4 pop-up waste
Batterie de bidet 3 trous, goulot orientable style
ancien, vidage 1"1/4

CR  BR 

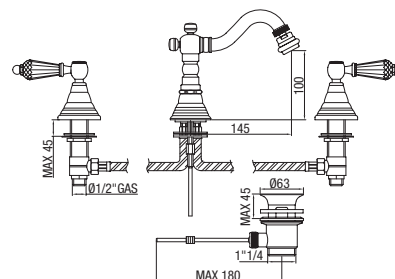

VC
(art.291SX)
(art.291DX)



635SW

Monoforo bidet con canna anticata girevole
scarico 1" 1/4
*Single hole bidet group with antique swivelling
spout, 1" 1/4 pop-up waste*
Batterie de bidet monotrou, goulot orientable style
ancien, vidage 1"1/4

CR  BR 

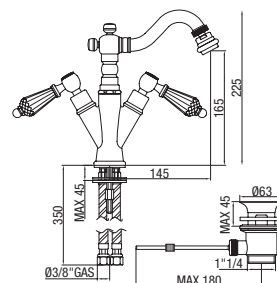

VC
(art.291SX)
(art.291DX)



606SW

Rubinetto incasso singolo 1/2"
con sede riportata
Built-in single valve 1/2" fitting
Robinet de fermeture à encastrer,
raccord 1/2"

329
Prolunga
Extension
Extension



CR  BR 

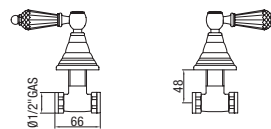



608SW-2V

Rubinetto incasso con deviatore 2 vie
Three-holes built-in group with 2 ways diverter
 Batterie trois trous à encastrer avec inverseur 2 voies

329

Prolunga
Extension
 Extension



329D

Prolunga
Extension
 Extension

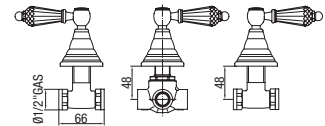

ARMONIA SW



607SW

Gruppo esterno doccia, attacco 1/2" inferiore,
 non corredato di componenti
External shower group without shower kit,
1/2" fitting
 Batterie de douche externe, raccord 1/2",
 sans flexible et sans douchette

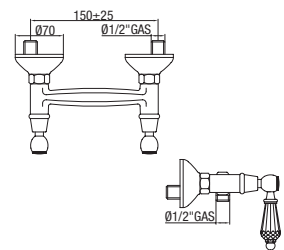

616SW

Gruppo esterno doccia, attacco 3/4 superiore",
 non corredato di componenti
External shower group without shower kit,
3/4" fitting
 Batterie de douche externe, raccord 3/4",
 sans flexible et sans douchette

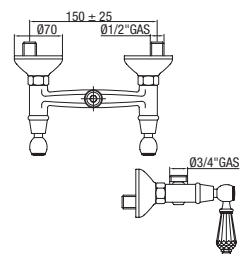





MARGHERITA

MARGHERITA

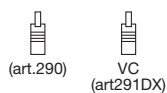

B01

Gruppo esterno vasca con doccia
External bath group with shower
 Batterie de bain externe avec douchette

B01VC

Con vitone ceramico
With ceramic headvalve
 Avec tête de robinet céramique

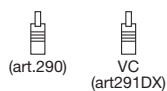
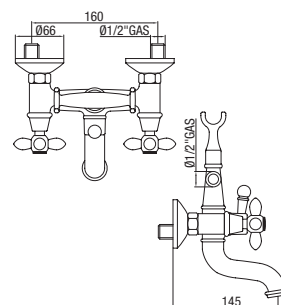

B02

Gruppo esterno vasca con doccia e duplex
External bath group with shower and duplex
 Batterie de bain externe avec douchette et support

B02VC

Con vitone ceramico
With ceramic headvalve
 Avec tête de robinet céramique

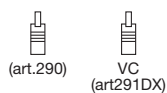
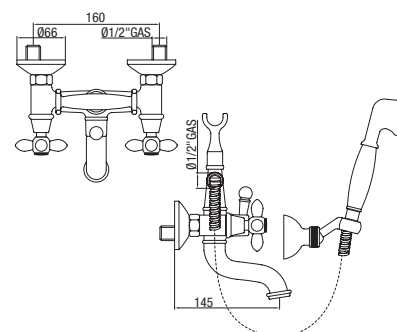

B03

Batteria lavabo 3 fori, scarico 1" 1/4
3 holes basin group, 1" 1/4 pop-up waste
 Batterie de lavabo 3 trous, vidage 1"1/4

B03VC

Con vitone ceramico
With ceramic headvalve
 Avec tête de robinet céramique

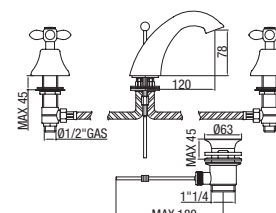

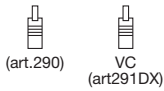

B04

Batteria lavabo tre fori con bocca girevole **Ø 26 mm**, scarico 1" 1/4
 3 holes basin group, swivelling **Ø 26 mm** spout, 1" 1/4 pop-up waste

Batterie de lavabo 3 trous, goulot orientable **Ø 26 mm**, vidage 1"1/4



B04VC

Con vitone ceramico
 With ceramic headvalve
 Avec tête de robinet céramique

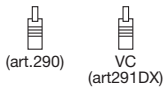
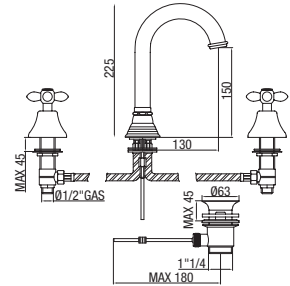

B08

Gruppo monoforo lavabo, scarico 1" 1/4
 Single hole basin group, 1" 1/4 pop-up waste
 Batterie de lavabo monotrou, vidage 1"1/4



B08VC

Con vitone ceramico
 With ceramic headvalve
 Avec tête de robinet céramique

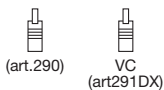
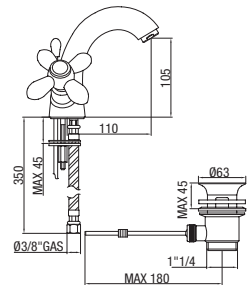

B07

Batteria bidet tre fori con bocca girevole **Ø26 mm**, scarico 1" 1/4
 3 holes bidet group, swivelling **Ø26 mm** spout, 1" 1/4 pop-up waste

Batterie de bidet 3 trous, goulot orientable **Ø26 mm**, vidage 1"1/4



B07VC

Con vitone ceramico
 With ceramic headvalve
 Avec tête de robinet céramique

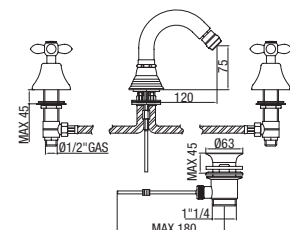

MARGHERITA

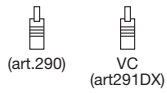

B05

Batteria bidet tre fori scarico 1" 1/4
3 holes bidet group, 1" 1/4 pop-up waste
 Batterie de bidet 3 trous, vidage 1"1/4

B05VC

Con vitone ceramico
With ceramic headvalve
 Avec tête de robinet céramique

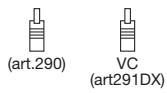
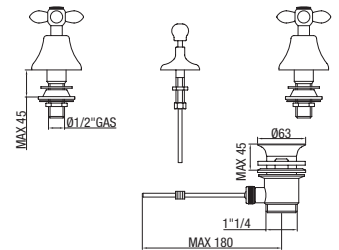

B10

Gruppo monoforo bidet, scarico 1" 1/4
Single hole bidet group, 1" 1/4 pop-up waste
 Batterie de bidet monotrou, vidage 1"1/4

B10VC

Con vitone ceramico
With ceramic headvalve
 Avec tête de robinet céramique

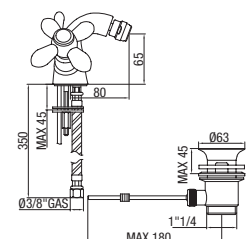

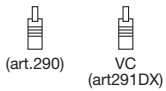

B06

Rubinetto incasso singolo 1/2"
 con sede riportata
1/2" fitting built-in single valve
 Robinet de fermeture à encastrer,
 raccord 1/2"

B06VC

Con vitone ceramico
With ceramic headvalve
 Avec tête de robinet céramique

329

Prolunga
Extension
 Extension

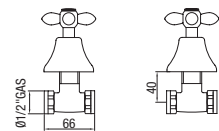

B16

Rubinetto incasso con deviatore 2 vie
Built-in group with 2 ways diverter
 Batterie à encastrer avec inverseur 2 voies

B16VC

Con vitone ceramico
With ceramic headvalve
 Avec tête de robinet céramique

329

Prolunga
Extension
 Extension



329D

Prolunga
Extension
 Extension

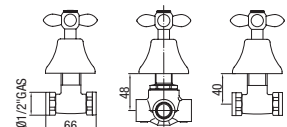





CINQUE

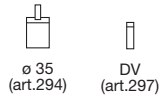

500

Miscelatore esterno vasca con doccia e duplex
External bath mixer with duplex and shower
 Mitigeur de bain externe avec support orientable
 et douchette

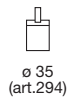
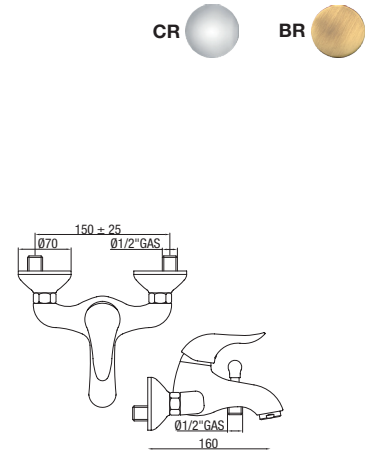

520

Miscelatore lavabo, scarico 1"1/4 lusso
Single lever basin mixer with 1"1/4 pop-up waste
 Mitigeur de lavabo, vidage 1"1/4 de luxe

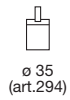
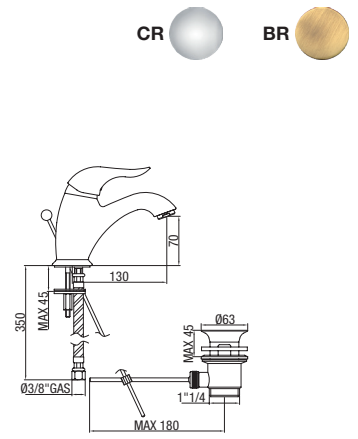

540

Miscelatore bidet, scarico 1"1/4 lusso
Single lever basin mixer with 1"1/4 pop-up waste
 Mitigeur de lavabo, vidage 1"1/4 de luxe

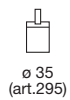
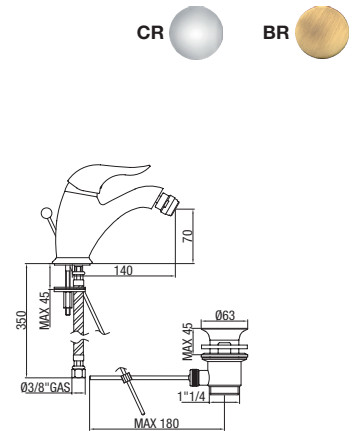

560

Miscelatore incasso doccia
Single lever built-in shower mixer
 Mitigeur à encastrer pour douche

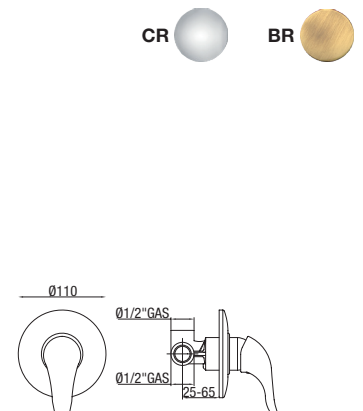

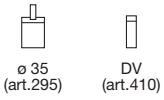

570

Miscelatore incasso doccia e vasca con deviatore click-clack
Single lever built-in shower and bath mixer with click-clack diverter
 Mitigeur de bain/douche à encastrer avec inverseur click-clack

570-S

Con scatola incasso
With built-in wall box
 Avec boîte à encastrer

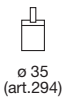
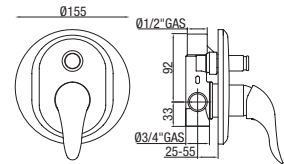

580

Miscelatore esterno doccia attacco 1/2", non corredato di componenti
External shower mixer without shower kit, 1/2" fitting
 Mitigeur douche externe, raccord 1/2", sans flexible et sans douchette

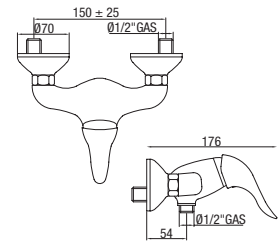





IMPERIAL





(1) Bianca - White - Blanc



(2) Ciliegio - Cherry-Wood - Cerise-bois



(3) Wengè - Wengé - Wengè

Le resine possono essere abbinata a piacere alla finitura del rubinetto
 The resin finishings can be matched with every taps finishing
 La finition en résine peut être combinée à tous les finitions des mitigeurs



700

Miscelatore esterno vasca con doccia anticalcare e duplex
 External single lever bath mixer with duplex and no-liming shower
 Mitigeur de bain externe avec support orientable et douchette anticalcaire

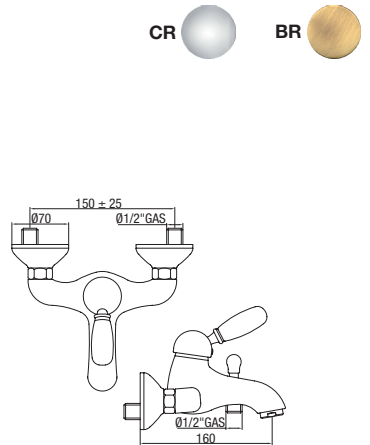

720

Miscelatore lavabo, scarico 1"1/4 lusso
 Single lever basin mixer with 1"1/4 pop-up waste
 Mitigeur de lavabo, vidage 1"1/4 de luxe

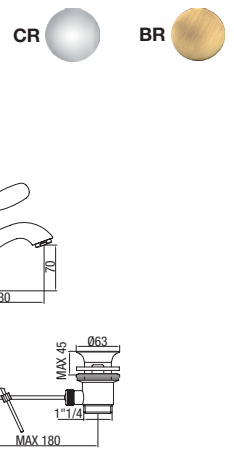

730

Miscelatore lavabo con canna anticata, orientabile, scarico 1" 1/4 lusso
 Single lever basin mixer with swivelling antique spout, 1" 1/4 pup-up waste
 Mitigeur de lavabo, goulot orientable style ancien, vidage 1"1/4 de luxe

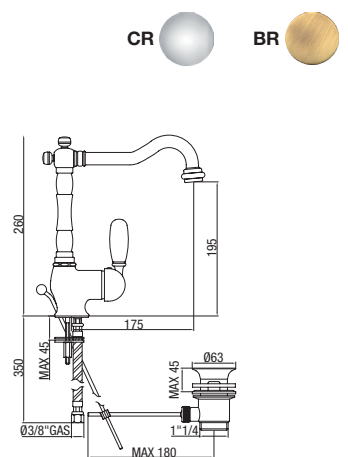

IMPERIAL



790

Miscelatore lavabo incasso,
bocca interasse 210 mm
*Built-in basin mixer,
210 mm spout wheelbase*
Mitigeur de lavabo à encastrer
goulot écartement 210 mm

309
1" 1/4

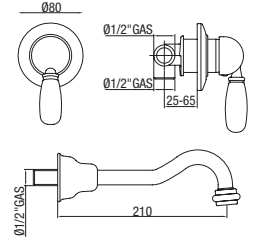

740

Miscelatore bidet, scarico 1"1/4 lusso
Single lever basin mixer with 1"1/4 pop-up waste
Mitigeur de lavabo, vidage 1"1/4 de luxe

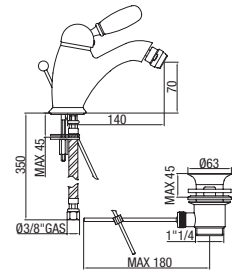

750

Miscelatore bidet con canna anticata, orientabile,
scarico 1" 1/4 lusso
*Single lever bidet mixer with swivelling antique
spout, 1" 1/4 pup-up waste*
Mitigeur de bidet, goulot orientable style ancien,
vidage 1"1/4 de luxe

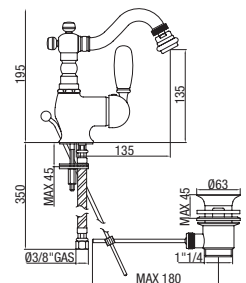

760

Miscelatore incasso doccia
Single lever built-in shower mixer
Mitigeur à encastrer pour douche

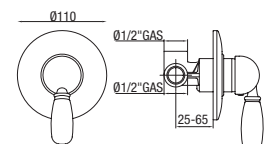



ø 35
(art.295)



770

Miscelatore incasso doccia e vasca
con deviatore click-clack
*Single lever built-in shower and bath mixer
with click-clack diverter*

Mitigeur de bain/douche à encastrer avec inverseur
click-clack

770-S

Con scatola incasso
With built-in wall box
Avec boîte à encastrer

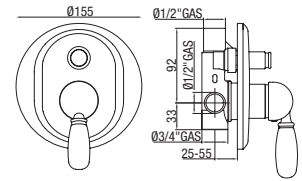

ø 35
(art.294)



780

Miscelatore esterno doccia attacco 1/2",
non corredato di componenti
*External shower mixer without shower kit,
1/2" fitting*

Mitigeur douche externe, raccord 1/2",
sans flexible et sans douchette

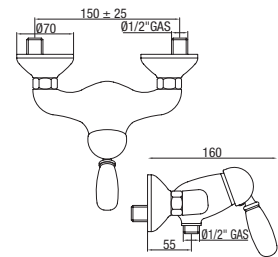

CRISTAL



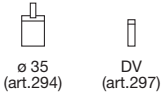

700SW

Miscelatore esterno vasca con doccia e duplex
External single lever bath mixer with duplex and shower
 Mitigeur de bain externe avec support orientable et douchette

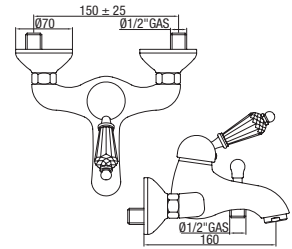

720SW

Miscelatore lavabo, scarico 1"1/4 lusso
Single lever basin mixer, 1"1/4 pop-up waste
 Mitigeur de lavabo, vidage 1"1/4 de luxe

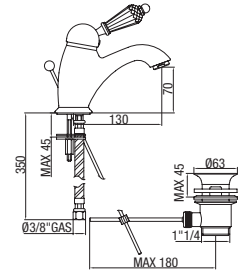

730SW

Miscelatore lavabo con canna anticata, orientabile, scarico 1" 1/4 lusso
Single lever basin mixer with swivelling antique spout, 1" 1/4 pup-up waste
 Mitigeur de lavabo, goulot orientable style ancien, vidage 1"1/4 de luxe

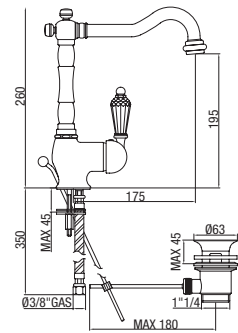

790SW

Miscelatore lavabo incasso, bocca interasse 210 mm
Built-in basin mixer, 210 mm spout wheelbase
 Mitigeur de lavabo à encastrer goulot écartement 210 mm

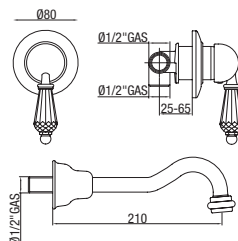

309
 1" 1/4



CRISTAL



ø 35
(art.294)



740SW

Miscelatore bidet, scarico 1"1/4 lusso
Single lever basin mixer with 1"1/4 pop-up waste
Mitigeur de lavabo, vidage 1"1/4 de luxe

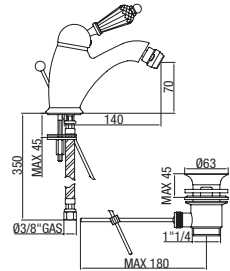

ES
(art.295A)



750SW

Miscelatore bidet con canna anticata, orientabile, scarico 1" 1/4 lusso
Single lever bidet mixer with swivelling antique spout, 1" 1/4 pup-up waste
Mitigeur de bidet, goulot orientable style ancien, vidage 1"1/4 de luxe

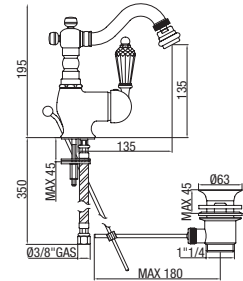

ø 35
(art.295)



760SW

Miscelatore incasso doccia
Single lever built-in shower mixer
Mitigeur à encastrer pour douche

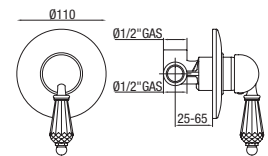

ø 35
(art.295)



DV
(art.410)



770SW

Miscelatore incasso doccia e vasca con deviatore click-clack
Single lever built-in shower and bath mixer with click-clack diverter

Mitigeur de bain/douche à encastrer avec inverseur click-clack

770SW-S

Con scatola incasso
With built-in wall box
Avec boîte à encastrer

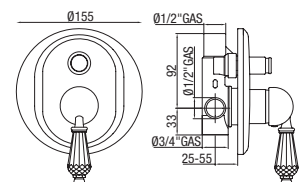



ø 35
(art.294)



780SW

Miscelatore esterno doccia attacco 1/2",
non corredato di componenti
*External shower mixer without shower kit,
1/2" fitting*
Mitigeur douche externe, raccord 1/2",
sans flexible et sans douchette

CR  BR 

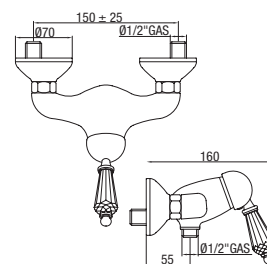





VANITY

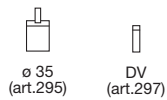

ø 35
(art.295)

DV
(art.297)

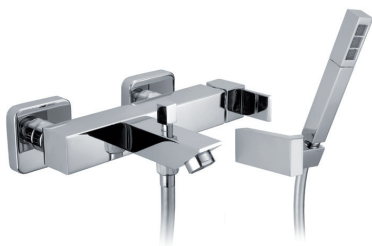

V10

Miscelatore esterno vasca con leva laterale, doccia e duplex
External bath mixer with single lateral lever, duplex and shower
Mitigeur de bain externe avec levier latéral, support orientable et douche

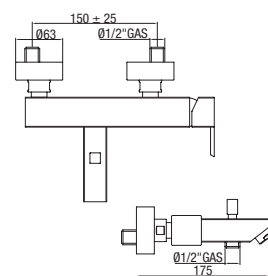

CR

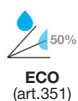

ECO
(art.351)



V20

Miscelatore lavabo, scarico 1"1/4
Single lever basin mixer, 1"1/4 pop-up waste
Mitigeur de lavabo, vidage 1"1/4

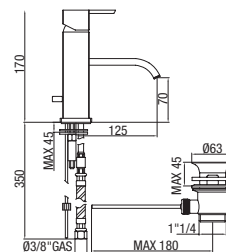

CR

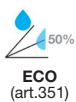

ECO
(art.351)



V20TC

Miscelatore lavabo, senza scarico
Single lever basin mixer, without pop-up waste
Mitigeur de lavabo, sans vidage

425

Universal 1" 1/4



426

Universal 1" 1/4

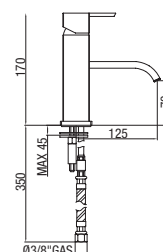

CR



ECO
(art.351)



V30

Miscelatore lavabo prolungato senza scarico
h 245 mm
Extended single lever basin mixer without pop-up waste h 245 mm
 Mitigeur de lavabo surélevé sans vidage
h 245 mm

425

Universal 1" 1/4



426

Universal 1" 1/4

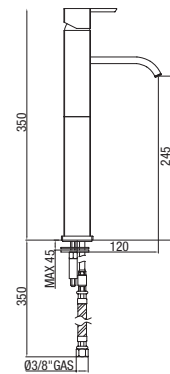

CR



ECO
(art.351)



V30S

Miscelatore lavabo prolungato senza scarico
h 245 mm, bocca interasse 170 mm
Extended single lever basin mixer without pop-up waste h 245 mm, 170 mm spout wheelbase
 Mitigeur de lavabo surélevé sans vidage
h 245 mm, goulot écartement 170 mm

425

Universal 1" 1/4



426

Universal 1" 1/4

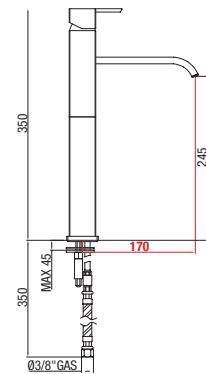

CR



ECO
(art.351)



V35

Miscelatore lavabo, scarico 1"1/4
Single lever basin mixer, 1"1/4 pop-up waste
 Mitigeur de lavabo, vidage 1"1/4

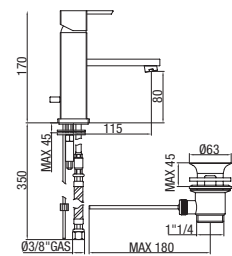

CR



ECO
(art.351)



V35TC

Miscelatore lavabo, senza scarico
Single lever basin mixer, without pop-up waste
 Mitigeur de lavabo, sans vidage

425

Universal 1" 1/4



426

Universal 1" 1/4

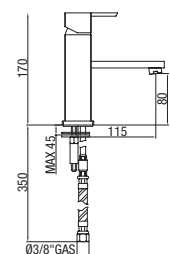

CR

VANITY



ECO
(art.351)



V50

Miscelatore lavabo prolungato
senza scarico **h 255 mm**
*Extended single lever basin mixer
without pop-up waste h 255 mm*
Mitigeur de lavabo surélevé
sans vidage **h 255 mm**

425

Universal 1" 1/4



426

Universal 1" 1/4

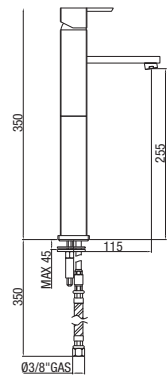

CR



ECO
(art.351)



V50S

Miscelatore lavabo prolungato senza scarico
h 255 mm, bocca interasse 170 mm
*Extended single lever basin mixer without pop-up
waste h 255 mm, 170 mm spout wheelbase*
Mitigeur de lavabo surélevé sans vidage
h 255 mm, goulot écartement 170 mm

425

Universal 1" 1/4



426

Universal 1" 1/4

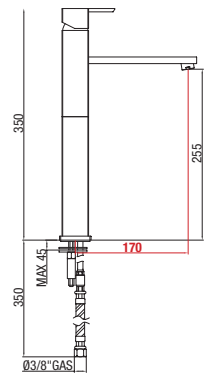

CR



ES
(art.295A)



V141

Miscelatore lavabo prolungato,
senza scarico, canna orientabile
*Extended single lever basin mixer
without pop-up waste, swivelling spout*
Mitigeur de lavabo surélevé
sans vidage, goulot orientable

425

Universal 1" 1/4



426

Universal 1" 1/4

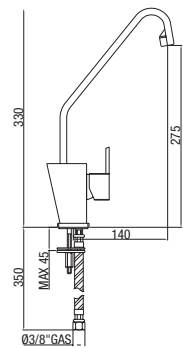

CR



ES
(art.295A)



V142

Miscelatore lavabo, senza scarico, canna orientabile
*Single lever basin mixer without pop-up waste,
swivelling spout*
Mitigeur de lavabo sans vidage, goulot orientable

425

Universal 1" 1/4



426

Universal 1" 1/4

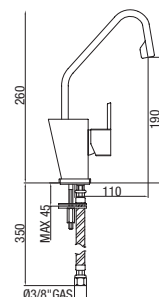

CR



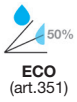

V40

Miscelatore bidet scarico 1"1/4
 Single lever bidet mixer, 1"1/4 pop-up waste
 Mitigeur de bidet, vidage 1"1/4

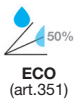
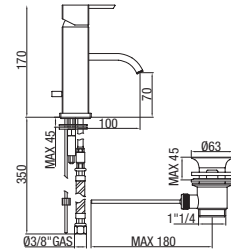

V45

Miscelatore bidet scarico 1"1/4
 Single lever bidet mixer, 1"1/4 pop-up waste
 Mitigeur de bidet, vidage 1"1/4

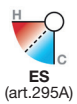
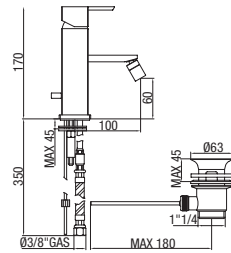

V143

Miscelatore bidet senza scarico, canna orientabile
 Single lever bidet mixer without pop-up waste, swivelling spout
 Mitigeur de bidet surélevé sans vidage, goulot orientable

425

Universal 1" 1/4



426

Universal 1" 1/4

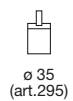
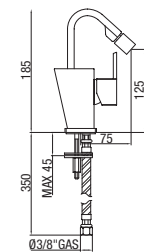

V60

Miscelatore incasso doccia
 Single lever built-in shower mixer
 Mitigeur à encastrer pour douche

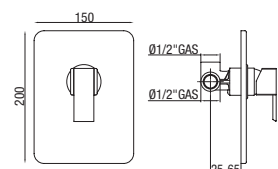

VANITY

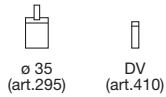

V70

Miscelatore incasso doccia e vasca con deviatore click-clack
Single lever built-in shower and bath mixer with click-clack diverter

Mitigeur de bain/douche à encastrer avec inverseur click-clack

V70-S

Con scatola incasso
With built-in wall box
 Avec boîte à encastrer

V72

Miscelatore incasso doccia e vasca con deviatore click-clack e piastra acciaio
Single lever built-in shower and bath mixer with click-clack diverter and stainless steel plate

Mitigeur de bain/douche à encastrer avec inverseur click-clack et plaque en acier inox



V72-S

Con scatola incasso
With built-in wall box
 Avec boîte à encastrer

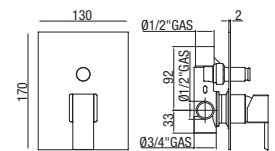
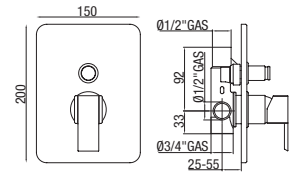

CR

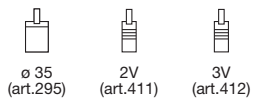

V75-2V

Miscelatore incasso doccia con deviatore ceramico 2 vie
Single lever built-in shower mixer with 2 ways ceramic diverter

Mitigeur de douche à encastrer avec inverseur ceramique 2 voies

V75-S-2V

Con scatola incasso
With built-in wall box
 Avec boîte à encastrer

V75-3V

3 vie
 3 ways
 3 voies

V75-S-3V

3 vie con scatola incasso
 3 ways *with built-in wall box*
 3 voies *avec boîte à encastrer*

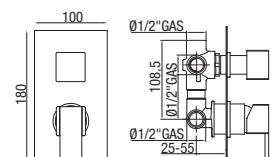
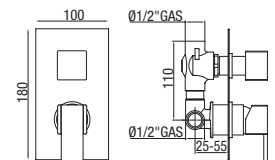

CR



ø 35
(art.295)



V80

Miscelatore esterno doccia con leva laterale,
att. 1/2", non corredato di componenti

*External shower mixer with lateral lever
without shower kit, 1/2" fitting*

Mitigeur douche externe avec levier lateral,
raccord 1/2", sans flexible et sans douchette

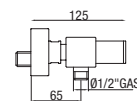
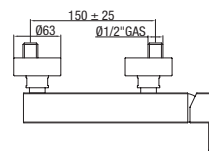

ø 35
(art.295)



V90

Miscelatore esterno doccia con leva laterale,
att. 3/4", non corredato di componenti

*External shower mixer with lateral lever
without shower kit, 3/4" fitting*

Mitigeur douche externe avec levier lateral,
raccord 3/4", sans flexible et sans douchette

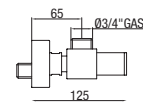
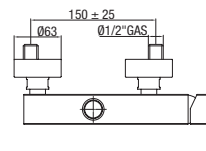

JUMPY



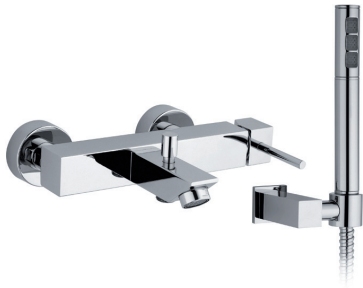
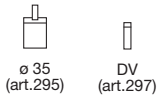

Q10

Miscelatore esterno vasca con leva laterale, doccia e duplex
External bath mixer with single lateral lever, duplex and shower
 Mitigeur de bain externe avec levier latéral, support orientable et douchette

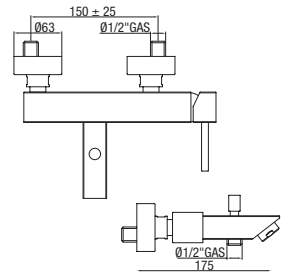

Q20

Miscelatore lavabo, scarico 1"1/4
Single lever basin mixer, 1"1/4 pop-up waste
 Mitigeur de lavabo, vidage 1"1/4

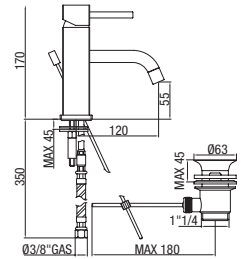

Q20TC

Miscelatore lavabo, senza scarico
Single lever basin mixer, without pop-up waste
 Mitigeur de lavabo, sans vidage

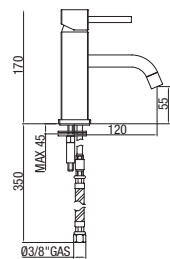

425

Universal 1" 1/4



426

Universal 1" 1/4



Q30

Miscelatore lavabo prolungato senza scarico h 235 mm
Extended single lever basin mixer without pop-up waste h 235 mm
 Mitigeur de lavabo surélevé sans vidage h 235 mm

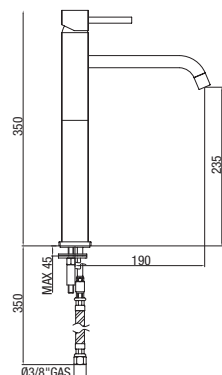

425

Universal 1" 1/4



426

Universal 1" 1/4



JUMPY

 ø 35
 (art.295)



Q40

Miscelatore bidet scarico 1"1/4
Single lever bidet mixer, 1"1/4 pop-up waste
 Mitigeur de bidet, vidage 1"1/4

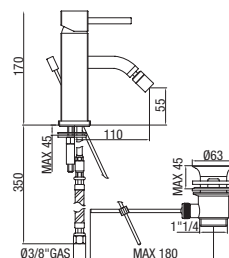

CR





 ø 35
 (art.295)

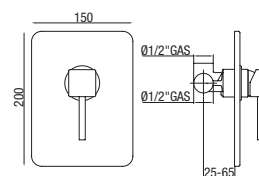

Q60

Miscelatore incasso doccia
Single lever built-in shower mixer
 Mitigeur à encastrer pour douche



CR





 ø 35
 (art.295)

 DV
 (art.410)

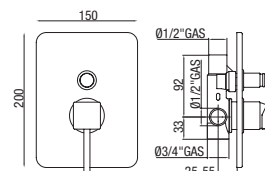

Q70

Miscelatore incasso doccia e vasca
 con deviatore click-clack
*Single lever built-in shower and bath mixer
 with click-clack diverter*
 Mitigeur de bain/douche à encastrer avec inverseur
 click-clack



CR



 ø 35
 (art.295)



 2V
 (art.411)

 3V
 (art.412)

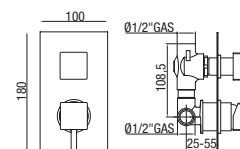

Q75-2V

Miscelatore incasso doccia
 con deviatore ceramico 2 vie
*Single lever built-in shower mixer
 with 2 ways ceramic diverter*
 Mitigeur de douche à encastrer
 avec inverseur ceramique 2 voies



CR



Q75-3V

3 vie
 3 ways
 3 voies

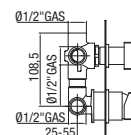



ø 35
(art.295)



Q80

Miscelatore esterno doccia con leva laterale,
att. 1/2", non corredato di componenti

*External shower mixer with lateral lever
without shower kit, 1/2" fitting*

Mitigeur douche externe avec levier lateral,
raccord 1/2", sans flexible et sans douchette

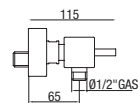
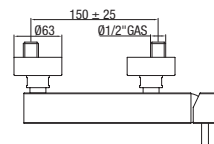

CR



ø 35
(art.295)



Q90

Miscelatore esterno doccia con leva laterale,
att. 3/4", non corredato di componenti

*External shower mixer with lateral lever
without shower kit, 3/4" fitting*

Mitigeur douche externe avec levier lateral,
raccord 3/4", sans flexible et sans douchette

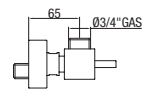
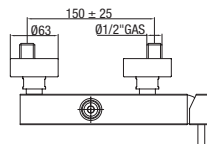

CR

